



CUMMINS





Cenmak Ltd Co. has 30 years experience in export and import activities in an automotive parts sector.

Cenmak is an export and import centered company in İzmir.





We supply high quality and reliable auto spare parts for many brands and models.

Cenmak is a customer satisfaction oriented company and know that the quality is the most important factor in customer satisfaction. Because of the succesful product sales Cenmak Ltd. Co. has wide and respectable customer portfolio.





We are trying to support our customers for competitive markets.



Cummins Engine Parts

B SERIES						4 Cylinder Bore 102.MM Stroke 120.MM
CENMAK REF		PISTON KIT	PISTON BODY	RING SET	COMMENTS	Ø
CCM10228PS	4B-BT-BTA3.9 6B-BT-BTA5.9	3802060	3906223	3802040	STD.	102,MM
CCM10228.050 PS		3802062	3906209	3802042	0.50MM	
CCM10228.100 PS		3802064	3906208	3802044	1.00MM	
CCM10229PS		3802100	3907156	3802230	STD.	
CCM10229.050 PS		3802102	3907157	3802232	0.50MM	
CCM10229.100 PS		3802104	3907158	3802234	1.00MM	
CCM10230PS		3802160	3907163	3802230	STD.	
CCM10230.050 PS		3802132	3908815	3802232	0.50MM	
CCM10230.100 PS		3802134	3908816	3802234	1.00MM	
CCM10231PS		3802170	3911400	3802230	STD.	
CCM10231.050 PS		3802172	3912049	3802232	0.50MM	
CCM10231.100 PS		3802174	3912050	3802234	1.00MM	
CCM10232PS		3802030	3903579	3802230	STD.	
CCM10232.050 PS		3802032	3903656	---	0.50 MM	
CCM10232.100 PS		3802034	3903655	---	1.00 MM	
CCM10233PS		3802251	3917619	3802230	STD.	
CCM10233.050 PS		3802252	3919047	---	0.50 MM	
CCM10233.100 PS		3802253	3919048	---	1.00 MM	
CCM10234PS		3802248	3919041	3802421	STD.	
CCM10234.050 PS		3802249	3919044	---	0.50 MM	
CCM10234.100 PS		3802250	3919045	---	1.00 MM	
CCM10235PS		3802487	3922571	3802421	STD.	
CCM10235.050 PS		3802493	3922574	---	0.50 MM	
CCM10235.100 PS		3802495	3922575	---	1.00 MM	
CCM10236PS		3802561-62-63	3926631-32-33	3802230	STD.	
CCM10236.050 PS		3802564	3926634	---	0.50 MM	
CCM10236.100 PS		3802565	3926635	---	1.00 MM	

Cummins Engine Parts

C SERIES					6 Cylinder Bore 114.MM Stroke 135.MM
CENMAK REF	6CT-CTA 8.3	PISTON KIT	PISTON BODY	RING SET	Ø
3802263		3802263	3917707	3802439	114.MM
3802280		3802280	3919566		
3802344		3802344	3919247		
3802396		3802396	3923165		
3802397		3802397	3923163		
3802398		3802398	3923164		
3802657		3802657	3919161		
3802474		3802474	3923537		
3802601		3802601	3925878		
3802602		3802602	3925879		
3802603		3802603	3925880		
3802604		3802604	3925881		
3802460		3802460	3926961		
3802461		3802461	3926962		
3802462		3802462	3926963		
3802568		3802568	3926964		

N SERIES					6 Cylinder Bore 5.500 Stroke 6.000
CENMAK REF	NT855-NTCC230 NTC 230-240-270-400 N14	PISTON KIT	PISTON BODY	RING SET	Ø
3801057		3801057	3017348	3801056	3801056-3803471
3801058		3801058	3017349		
3801766		3801766	3051553		
3801876		3801876	3051554		
3801770		3801770	3051555		
3801773		3801773	3051556		
3801393		3801393	3051557		
3801819		3801819	3048808	3803471	
3801820		3801820	3048809		
3803752		3803752	3081266	3804500	
3803754		3803754	3081268		
3803756		3803756	3081267		
3803758		3803758	3081269		

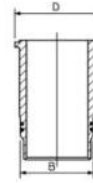

Cummins Engine Parts

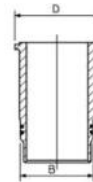

4B-6B-6CT-SERIES				
CENMAK REF	CUMMINS REF	ENGINE	DESCRIPTION	COMMENTS
CCM30061	3904166	6BTAA 5.9-4BTA 3.9-6BT 5.9	LINER STD.	102 MM
CCM30062	3904166	6BTAA 5.9-4BTA 3.9-6BT 5.9	LINER STD.	102 MM
CCM30062.050	3904167	6BTAA 5.9-4BTA 3.9-6BT 5.9	LINER 0.50MM	102 MM
CCM30062.100	3904168	6BTAA 5.9-4BTA 3.9-6BT 5.9	LINER 1.00MM	102 MM
CCM30063	3745340	6CT 8.3-6CTAA 8.3	LINER STD.	114 MM
CCM30064	3745490	6CT 8.3-6CTAA 8.3	LINER STD.	114 MM
CCM30065	3800328	6CT 8.3-6CTAA 8.3-6CTAA EURO1	LINER SHORT	114 MM
CCM30066	3745490	6CT 8.3-6CTAA 8.3	LINER LONG	114 MM
CCM30067	3800328	6CT 8.3-6CTAA 8.3	LINER SHORT	114 MM



N SERIES				
CENMAK REF	CUMMINS REF	ENGINE	DESCRIPTION	
CCM30068	3055099	NH250-NT855	LINER std	
CCM30069	184400	NH250-NH220-743	LINER	

6CT 8.3		 		
CENMAK REF	CUMMINS REF	ENGINE	DESCRIPTION	
CCM30070	3907177	6CT 8.3-6CTAA 8.3	Liner seal ring	

CUMMINS VALVE TRAIN COMPONENTS



4-6 BT SERIES

CENMAK REF	DESCRIPTION		CUMMINS REF
CCM40522	Valve Exhaust <i>STD</i>	4B-4BT-BTA 3.9/6B-BT-BTA 5.9	3920868-3901117
CCM40523	Valve Inlet <i>STD</i>		3920867-3901117
CCM40522. <i>0.50</i>	Valve Exhaust <i>0.50</i>		3920868-3901117
CCM40523. <i>0.50</i>	Valve Inlet <i>0.50</i>		3920867-3901117
CCM40522. <i>1.00</i>	Valve Exhaust <i>1.00</i>		3920868-3901117
CCM40523. <i>1.00</i>	Valve Inlet <i>1.00</i>		3920867-3901117
CENMAK REF	VALVE GUIDE	ENGINE	CUMMINS REF
CCM40524	Valve guide Inlet	4B-4BT-BTA 3.9/6B-BT-BTA 5.9 (68.50 mm)long	3904408
CCM40525	Valve guide Exhaust	4B-4BT-BTA 3.9/6B-BT-BTA 5.9 (51.75 mm)long	3904409

N SERIES

CENMAK REF	DESCRIPTION		CUMMINS REF
CCM40526	INT INSERT-EXH INSERT	NT855	3017759-200354
CCM40527	Valve Inlet	NT7 43	69965
CENMAK REF	VALVE GUIDE	ENGINE	CUMMINS REF
CCM40528	Valve Guide	NT7 43	66890
CCM40529	Valve Guide	NT855	3050369
CCM40530	Valve Guide	NT855	3006456
CCM40531	Valve Guide <i>STD</i>	N14	3064312
CCM40531. <i>010</i>	Valve Guide <i>0.10</i>	N14	3072321
CCM40531. <i>015</i>	Valve Guide <i>0.15</i>	N14	3072322

6 CT SERIES

CENMAK REF	DESCRIPTION		CUMMINS REF
CCM40532	Valve Inlet <i>STD</i>	6CT-CTA 8.3	3924492
CCM40532. <i>050</i>	Valve Inlet <i>0.50</i>		3924492
CCM40533	Valve Inlet <i>STD</i>		3921444
CCM40533. <i>050</i>	Valve Inlet <i>0.50</i>		3921444
CENMAK REF	VALVE GUIDE	ENGINE	CUMMINS REF
CCM40534	Valve guide	6CT-CTA 8.3	3901187
CENMAK REF	DESCRIPTION		CUMMINS REF
CCM40535	Seal valve stem (Black)	4BT3.9-6BT5.9	3901097
CCM40536	Seal valve stem	6CT-CTA 8.3	3915707-3912549 3912550

CYLINDER HEAD GASKET

4-6 BT SERIES

CENMAK REF	CUMMINS REF		DESCRIPTION
CCM40538	3921394-3802361-3918302 3283569-3921393-3282999	4BT 3.9	Gasket cylinder head
CCM40539	3283570-3283335-3915729	6B-BT-BTA 5.9	Gasket cylinder head

6 CT SERIES

CENMAK REF	CUMMINS REF		DESCRIPTION
CCM40537	3907682-3935585	6CT 8.3-6CTAA 8.3	Gasket cylinder head (Graphite)

N SERIES

CENMAK REF	CUMMINS REF		DESCRIPTION
CCM40542	3047402	NT855	Gasket cylinder head
CCM40543	4058790	N14	Gasket cylinder head

UPPER LOVER GASKET SET

6CT SERIES

CENMAK REF	DESCRIPTION		CUMMINS REF
CCM40546	Upper set	6CT 8.3	3802624
CCM40547	Lower set		3802389

6BT SERIES

CENMAK REF	DESCRIPTION		CUMMINS REF
CCM40548	Upper gasket set	6B-BT-BTA 5.9	3804897
CCM40549	Lower gasket set		3802376
CCM40550	Upper set		3802363-3804897
CCM40551	Lower set		3802376

4BT SERIES

CENMAK REF	DESCRIPTION		CUMMINS REF
CCM40552	Upper set	4B-BT-BTA 3.9	3804896
CCM40553	Lower gasket set		3802375

N SERIES

CENMAK REF	DESCRIPTION		CUMMINS REF
CCM40554	Upper set	N743	3802076
CCM40555	Lower gasket set	N743	3802075
CCM40556	Upper set	NH220	3802077
CCM40557	Lower gasket set	NH220	3801466
CCM40558	Upper set	N14	3803716
CCM40559	Lower gasket set	N14	3803613
CCM40560	Upper set	N14 STC	3803713
CCM40561	Lower gasket set	N14 STC	3803613

GASKETS

6CT SERIES

CENMAK REF	DESCRIPTION		CUMMINS REF
CCM40562	Gaslet vale Rover	6CT-6CTA 8.3	3905449
CCM40563	Gaslet intake Longa 19 Holve		3936993-3914311
CCM40564	Gasket intake Short 15 Holes		3921440
CCM40565	Gasket oil pan		3934044-3914017
CCM40566	Gasket manifold exhaust		3932063
CCM40567	Gasket oil cooler Filter header		3918332
CCM40568	Gasket oil cooler Core to block		3914307-3918174
CCM40569	Gasket oil cooler Filter header		3914308
CCM40570	Gasket front cover		3917780
CCM40571	Gasket front plate		3281721-3914303
CCM40572	Seal valve stem Black		3948578
CCM40573	Gasket oil sump		3914302
CCM40574	Gasket air compressor		3916042

6BT SERIES

CENMAK REF	DESCRIPTION		CUMMINS REF
CCM40575	Gasket valve cover	6B-6T-BTA 5.9	3902666
CCM40576	Gasket oil pan		3959052-3911536-3937072-3931346-3906028-3904577-3901287
CCM40577	Gasket manifold exhaust		3905443-3927154
CCM40578	Gasket manifold intake		3914029
CCM40579	Gasket oil cooler		3926760-3918256-3942914-3929791-3914387-3904427-3903318
CCM40580	Gasket front cover		3914385-3910500-3904492
CCM40581	Seal valve stem Black		3921640
CCM40582	Seal valve stem Orange		3901097
CCM40583	Gasket front housing		3940182-3916131-3931351
CCM40584	Gasket oil sump		3914302-3938157
CCM40585	Gasket air compressor		3916042

4BT SERIES

CENMAK REF	DESCRIPTION		CUMMINS REF
CCM40586	Gasket valve cover	4B-4T-BTA 3.9	3902666
CCM40587	Gasket oil pan		3911535
CCM40588	Gasket manifold exhaust		3905443-3927154
CCM40589	Gasket manifold intake		3914028
CCM40590	Gasket oil cooler		3926760-3918256-3942914-3929791-3914387-3904427-3903318
CCM40591	Gasket front cover		3914385-3910500-3904492
CCM40592	Seal valve stem Black		3921640
CCM40593	Seal valve stem Orange		3901097
CCM40594	Gasket front housing		3940182-3916131-3931351
CCM40595	Gasket oil sump		3914302-3914383
CCM40596	Gasket air compressor		3916042

N SERIES

CENMAK REF	DESCRIPTION		CUMMINS REF
CCM40597	Gasket valve cover	N14	3066311
CCM40598	Gasket oil pan	N14	3099083-3349820
CCM40599	Gasket oil cooler	NT855	142608
CCM40600	Gasket front cover	N14	3067618-4058949
CCM40601	Gasket manifold intake	855-NH220	3008591
CCM40602	Gasket oil sump	855-N14	157551
CCM40603	Gasket air compressor	855-N14	3069102

MAIN BEARING SETS

CENMAK REF	DESCRIPTION		CUMMINS REF
CCM40604	Main bearing std.	6CT-CTA 8.3	3802210-3945917
CCM40605	Connecting rod bearing std.		3901430
CCM40604. 025	Main bearing 0.25		3802211-3945918
CCM40605. 025	Connecting rod bearing 0.25		3901431
CCM40604. 050	Main bearing 0.50		3802212-3945919
CCM40605. 050	Connecting rod bearing 0.50		3901432
CCM40604. 075	Main bearing 0.75		3802213
CCM40605. 075	Connecting rod bearing 0.75		3901433
CCM40604. 100	Main bearing 1.00		3802214
CCM40605. 100	Connecting rod bearing 1.00		3901434
CCM40606	Bushing, connecting rod		3913990
CCM40607	Trhust bearing		3802112
CCM40608	Trhust bearing	3802114	
CENMAK REF	DESCRIPTION		CUMMINS REF
CCM40609	Main bearing std.	4RT-RTA 3.9	3802010
CCM40610	Connecting rod bearing std.		3901170
CCM40609. 025	Main bearing 0.25		3802011
CCM40610. 025	Connecting rod bearing 0.25		3901171
CCM40609. 050	Main bearing 0.50		3802012
CCM40610. 050	Connecting rod bearing 0.50		3901172
CCM40609. 075	Main bearing 0.75		3802013
CCM40610. 075	Connecting rod bearing 0.75		3901173
CCM40609. 100	Main bearing 1.00		3802014
CCM40610. 100	Connecting rod bearing 1.00		3901174
CCM40611	Bushing, connecting rod		3901085
CCM40612	Trhust bearing		3906230
CENMAK REF	DESCRIPTION		CUMMINS REF
CCM40613	Main bearing std.	6RT-RTA-RTAA 5.9	3802070
CCM40610	Connecting rod bearing std.		3901170
CCM40613. 025	Main bearing 0.25		3802071
CCM40610. 025	Connecting rod bearing 0.25		3901171
CCM40613. 050	Main bearing 0.50		3802072
CCM40610. 050	Connecting rod bearing 0.50		3901172
CCM40613. 075	Main bearing 0.75		3802073
CCM40610. 075	Connecting rod bearing 0.75		3901173
CCM40613. 100	Main bearing 1.00		3802074
CCM40610. 100	Connecting rod bearing 1.00		3901174
CCM40611	Bushing, connecting rod		3901085
CCM40612	Trhust bearing		3906230
CENMAK REF	DESCRIPTION		CUMMINS REF
CCM40617	Main bearing std.	N14-NT855-NT743-NH220	3801260
CCM40618	Connecting rod bearing std.		3055145
CCM40617. 010	Main bearing .010		3801261
CCM40618. 010	Connecting rod bearing .010		3055146
CCM40617. 020	Main bearing .020		3801262
CCM40618. 020	Connecting rod bearing .020		3055147
CCM40617. 030	Main bearing .030		3801263
CCM40618. 030	Connecting rod bearing .030		3055148
CCM40617. 040	Main bearing .040		3801264
CCM40618. 040	Connecting rod bearing .040		3055149
CCM40619	Bushing, connecting rod		187420

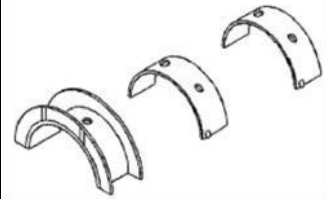

CAM SHAFT

CENMAK REF	DESCRIPTION		CUMMINS REF
CCM40620	CAM SHAFT	4B-BT-BTA 3.9	3929039-3925582-3914638
CCM40621		6B-BT-BTAA 5.9	3921953-3929041-3929042-3914639-3907824
CCM40622		6CT-CTA 8.3	3923478-3924471-3911236
CCM40623		NTA855	3946024
CCM40624		NTC855	3801763-3047452-3049023
CCM40625		NTA855	3042568
CCM40626		NTA855	3025518-3049024-3042586
CCM40627		N927/NT855/N743	3023177-3608842-3023229
CCM40628		N927/NT855/N743	3801030-3608840-3023228
CCM40629		N14	3801668
CCM40630		N14	3083932



CRANKSHAFT



CENMAK REF	DESCRIPTION		CUMMINS REF
CCM40631	CRANK SHAFT	6B-BT-BTAA 5.9	3907804-3908032
CCM40632	CRANKSHAFT (<i>STEEL FORGED</i>)	6B-BT-BTAA 5.9	3907804
CCM40633	CRANKSHAFT	4B-BT-BTA 3.9	3907803
CCM40634	CRANK SHAFT (<i>STEEL FORGED</i>)	6CT-CTA 8.3	3917320-3917443-3918986

CRANKSHAFT SEALS



CENMAK REF	DESCRIPTION		CUMMINS REF
CCM40635	Seal crankshaft front	4B-BT-BTA 3.9/6B-BT-BTA 5.9	3804899-3901979-3904353
CCM40636	Seal crankshaft front	6CT-CTA 8.3	3353977-3921927-3908139
CCM40637	Seal crankshaft rear	4B-BT-BTA 3.9/6B-BT-BTA 5.9	3909410-3909411-3926126
CCM40638	Seal crankshaft rear	6CT-CTA 8.3	3904089-3934486-3904087-3909410-3909411

Connection rod / bolt





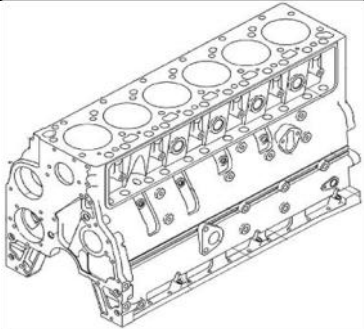

CENMAK REF	DESCRIPTION		CUMMINS REF
CCM40639	Connection rod	6CT-CTA 8.3	3971394-3901383
CCM40640	Connection rod	4B-BT-BTA 3.9/6B-BT-BTA 5.9	3925232-3942581-3901569-3901568
CCM40641	Connection rod Bolt	4B-BT-BTA 3.9-6B-BT-BTA 5.9	3900919
CCM40642	Connection rod Bolt	6CT-CTA 8.3	3928870-3920799-3901380

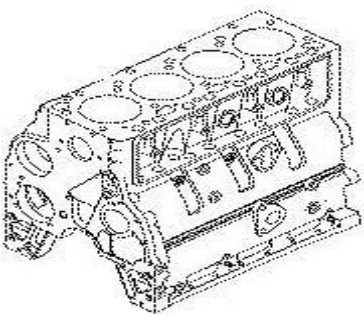
CYLINDER BLOCK / CYLINDER HEAD

CENMAK REF	DESCRIPTION		CUMMINS REF	
CCM40643	CYLINDER BLOCK	6BT	3903797-3934568	
CCM40644		6CT	3802408-3934900-3934906	
CCM40645		NTA855	3032187	

CENMAK REF	DESCRIPTION		CUMMINS REF	
CCM40646	CYLINDER BLOCK	4BT	3903920-3901735	









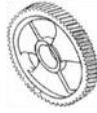

CENMAK REF	DESCRIPTION		CUMMINS REF	
CCM40647	CYLINDER HEAD	4BT	3920005-3920611	
CCM40648		6BT	3917055-3917287 3913391	
CCM40649		6CT	3911286-3936179	
CCM40650		N	3418529-3021692 3418678	

CENMAK REF	DESCRIPTION		CUMMINS REF
CCM40651	CYLINDER HEAD BOLT short (M12 x 1.75 x 70)	4B-BT-BTA 3.9-6B-BT-BTA 5.9	3920779
CCM40652	CYLINDER HEAD BOLT long (M12 x 1.75 x 120)		3920780







CCM40653	CYLINDER HEAD BOLT short (M14 x 2.00 x 80)	6CT-CTA 8.3	3917729
CCM40654	CYLINDER HEAD BOLT long (M14 x 2.00 x 160)		3917728

CENMAK REF	DESCRIPTION		CUMMINS REF
CCM40655	Nozzle piston cooling (short)	4B-BT-BTA 3.9-6B-BT-BTA 5.9	3901020
CCM40656	Nozzle piston cooling		6CT-CTA 8.3

ENGINE PARTS

CENMAK REF	DESCRIPTION		CUMMINS REF	
CCM40657	Pin Timing	4BT-6BT-6CT	3903924	
CCM40658	Key woodruuf	4BT-6BT	3902332	
CCM40659		6CT	3904485	
CCM40660	Gear cam shaft	4BT-6BT	3929028-3912884	
CCM40661		6BTAA	39221954	
CCM40662		6CT	3918777-3907328	
CCM40663	Cover Gear	6BT	3923896-3905203	
CCM40664		4BT	3280006	
CCM40665		6CT	3911649	
CCM40666	Plug	4BT-6BT	3904386	
CCM40667		6CT	3911638	
CCM40765	Rear Cover	4BT	3906526	
CCM40669		6BT	3936904-3921043	
CCM40670		6CT	3907535	
CCM40671	Damper vibration	4BT	3914494	
CCM40672		6CT	3914450	
CCM40673		6BT	3914454	
CCM40674	Gear crank shaft	6B-BT-BTAA 5.9	3929027	
CCM40675		4BT-6BT	3912883-3918375	
CCM40676		6CT	3907645-3918776	
CCM40677	Cam shaft thrust support	6CT	3901761	
CCM40678		4BT-6BT	3914641	
CCM40679	Plug expansion	4B-BT-BTA 3.9-6B-BT-RTA 5.9	3900687	
CCM40680		6CT-CTA 8.3	3901969	
CCM40681	Bearing cam	4B-BT-BTA 3.9-6B-BT-RTA 5.9	3901306	
CCM40682		6CT-CTA 8.3	3901685	

OIL PUMP

CENMAK REF	DESCRIPTION			CUMMINS REF
CCM40683	OIL PUMP	4B-BT-BTA 3.9		3937027-3926202
CCM40684		6B-BT-BTA 5.9		3937404-3941742-3926203 3924720-3918212-3914008 3914006-3946414-3943337 3901175
CCM40685		6CT-CTA 8.3		3910066-3914007-3930338 3802778-3800828-3948071
CCM40686		NTA855		3042378(AR9835)
CCM40687		NTC-30		3821579(3655113)
CCM40688		NTA855 NT855-374		AR10172

4B-6B-6CT SERIES

CENMAK REF	DESCRIPTION		CUMMINS REF
CCM40689	OIL COOLER	6B-BT-BTA 5.9	3921558-3957544 3942010-3902372 3918293-3911940
CCM40690		6CT-CTA 8.3	3918175
CCM40691		4B-BT-BTA 3.9	3921557-3918292 3904320



4-6 BT SERIES

N SERIES

CENMAK REF	DESCRIPTION		CUMMINS REF
CCM40692	OIL COOLER	NTC855	3045483-3018692
CCM40693		NTC855	3021581-208149
CCM40694		N SERIES	3028997
CCM40695		N SERIES	3419233
CCM40696		N SERIES	3419234



6 CT SERIES

TURBOCHARGERS

CENMAK REF	DESCRIPTION		CUMMINS REF
CCM40697	TURBOCHARGERS	6BTAA	3802391
CCM40698		6CT-CTA 8.3	3802909-3538856
CCM40699		6CT-CTA 8.3	3802345-3528708
CCM40700		4B-BT-BTA 3.9	3802290-3522900-3528743-3919145 3919146
CCM40701		6B-BT-BTA 5.9	3528237-3522777-3522778-3802289 3528741-3919127-3916349- 3523294
CCM40702		6BTAA	3802348
CCM40703		6CT-CTA 8.3	3527370-3802303-3524034-3528777 3802307







CENMAK REF	DESCRIPTION		CUMMINS REF
CCM40704	TURBOCHARGERS	NTC-350	3018066
CCM40705		NTC-290	3018067
CCM40706		NTC-230	3018654
CCM40707		NTCC-230	3019414
CCM40708		NTA-855	3023226
CCM40709		NT855	3024388
CCM40710		NT855-400	3523415
CCM40711		NT855-350	3522865
CCM40712		NT855-300	3522867
CCM40713		NT613	3522869A
CCM40714		N series	3529040
CCM40715		N series	3529041
CCM40716		NTR55	3032060
CCM40717		NTC400	3032062







CENMAK REF	DESCRIPTION		CUMMINS REF
CCM40718	TURBOCHARGES HOSE	4BT-6BT	3903745
CCM40719		6BT	3279245
CCM40720			3279246
CCM40721			92CT6K770
CCM40722		6CT	2K56167
CCM40723			2K55894
CCM40724			2K90272
CCM40725			2K67230
CCM40726			2K98417

WATER PUMP

4B-6B-6CT SERIES

CENMAK REF	DESCRIPTION		CUMMINS REF	WATER PUMP
CCM40727	WATER PUMP New assembly hardened pulley	4B-BT-BTA 3.9 6B-BT-BTA 5.9	181815-3286277 3802970-3802358 3802004-3913432	
CCM40728	WATER PUMP New 76mm pulley	4B-BT-BTA 3.9 6B-BT-BTA 5.9	3802972	
CCM40729	WATER PUMP New assembly with seal	6CT-CTA 8.3	181818-3802081 3929615-3806180 3802975 3913430	

N SERIES

CENMAK REF	DESCRIPTION		CUMMINS REF	WATER PUMP
CCM40730	WATER PUMP	NTA855-M	3655857-3010328	
CCM40731		NTA855 NTC290 NTC350 NTC400	3022474	
CCM40732		NH220-CI	3945361	

V BELT



<i>CENMAK REF</i>	<i>OEM REF</i>	<i>DESCRIPTION</i>	
CCM40900	8PK1365	V BELT	6B-BT-BTA 5.9
CCM40901	8PK1475		6CT-CTA 8.3
CCM40902	3534		6B-BT-BTA 5.9
CCM40903	3817		6CT-CTA 8.3
CCM40906	8PK1395		6B-BT-BTA 5.9
CCM40907	8PK1535	V BELT (New)	6CT-CTA 8.3

FUEL TRANSFER PUMP

CENMAK REF	DESCRIPTION		CUMMINS REF
CCM40733	FUEL TRANSFER PUMP	4B-BT-BTA 3.9	3904374-3936323
CCM40734		4B-BT-BTA 3.9-6B-BT-BTA 5.9	3928143
CCM40735		4B-BT-BTA 3.9 6B-BT-BTA 5.9 6CT-CTA 8.3	3936316-3933252
CCM40736			3936318-3933254-3917998
CCM40737			3936320-3933256-3918076
CCM40738		6B-BT-BTA 5.9-6CT-CTA 8.3	3933255
CCM40739			3936317-3933253
CCM40740			3936319
CCM40741		6B-BT-BTA 5.9	3936321-3936324
CCM40742		6CT-CTA 8.3	3918000



AIR COMPRESSOR



CUMMINS REF	CENMAK REF	ENGINE
3279008	CCM40743	4BT



CUMMINS REF	CENMAK REF	ENGINE
3279334-3281461	CCM40745	6BT





CUMMINS REF	CENMAK REF	ENGINE
3906255	CCM40744	6BT

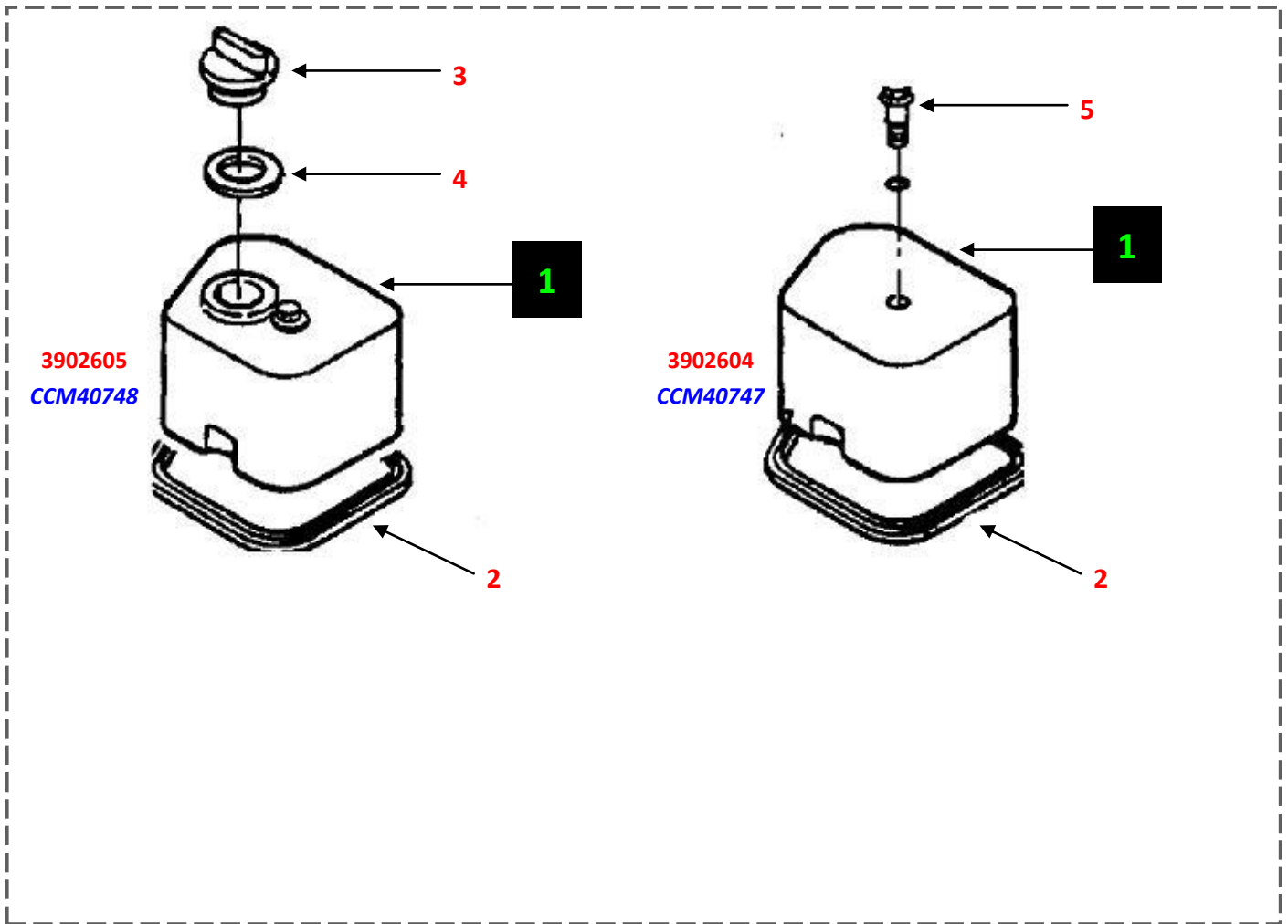

CUMMINS REF	CENMAK REF	ENGINE
3558006	CCM40746	6CT

VALVE COVER 4-6 BT



CENMAK REF	CUMMINS REF	DESCRIPTION	PART NO	
CCM40747-48	3902604-3902605	Cover Valve	1	 4/6 BT
CCM40750	3902666	Cover Valve Gasket	2	
CCM40753	3901895	Cap oil filler	3	
CCM40756	3902363	Seal	4	
CCM40759	3907049	Bolt	5	

VALVE COVER 6 CT

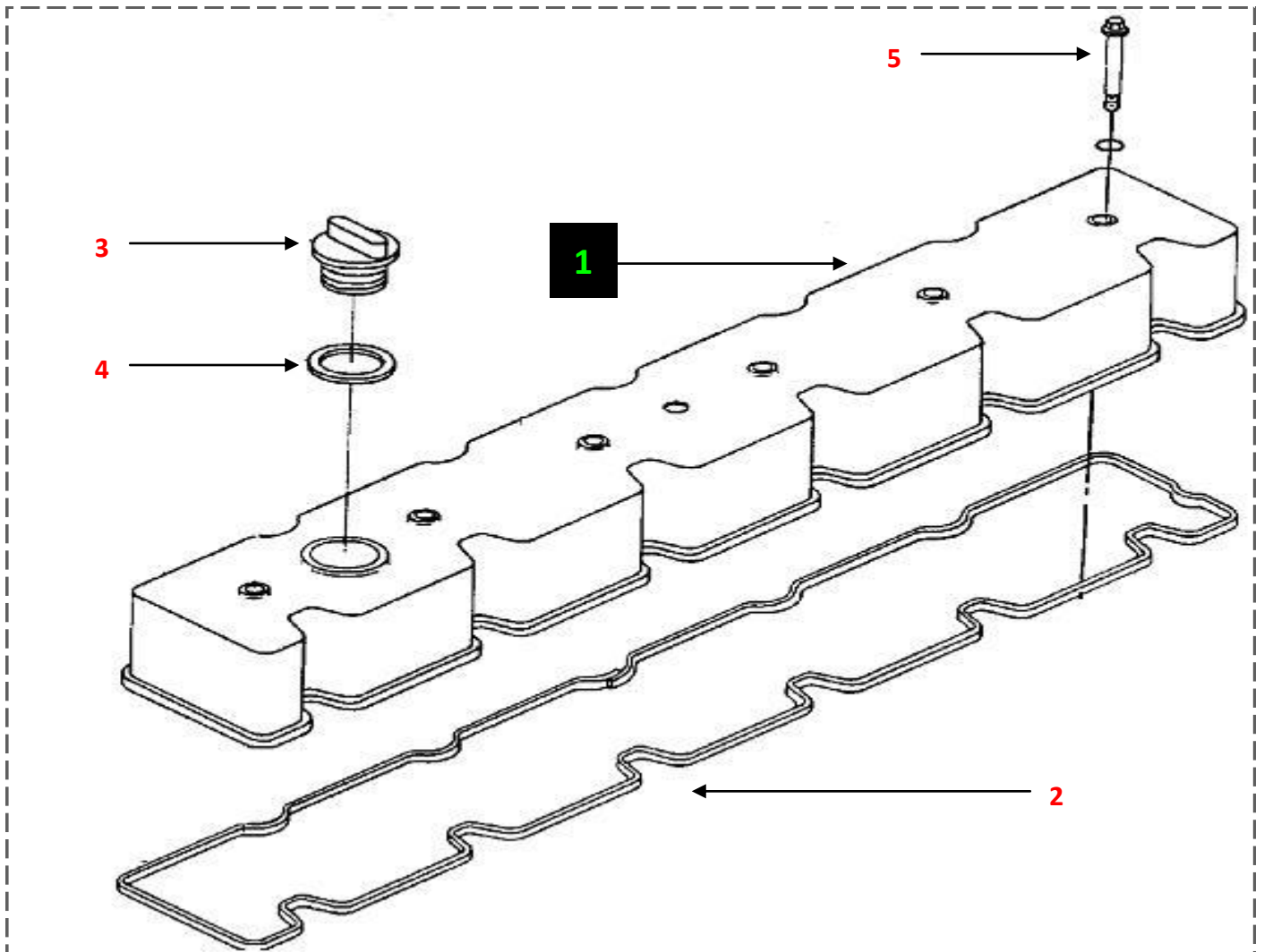



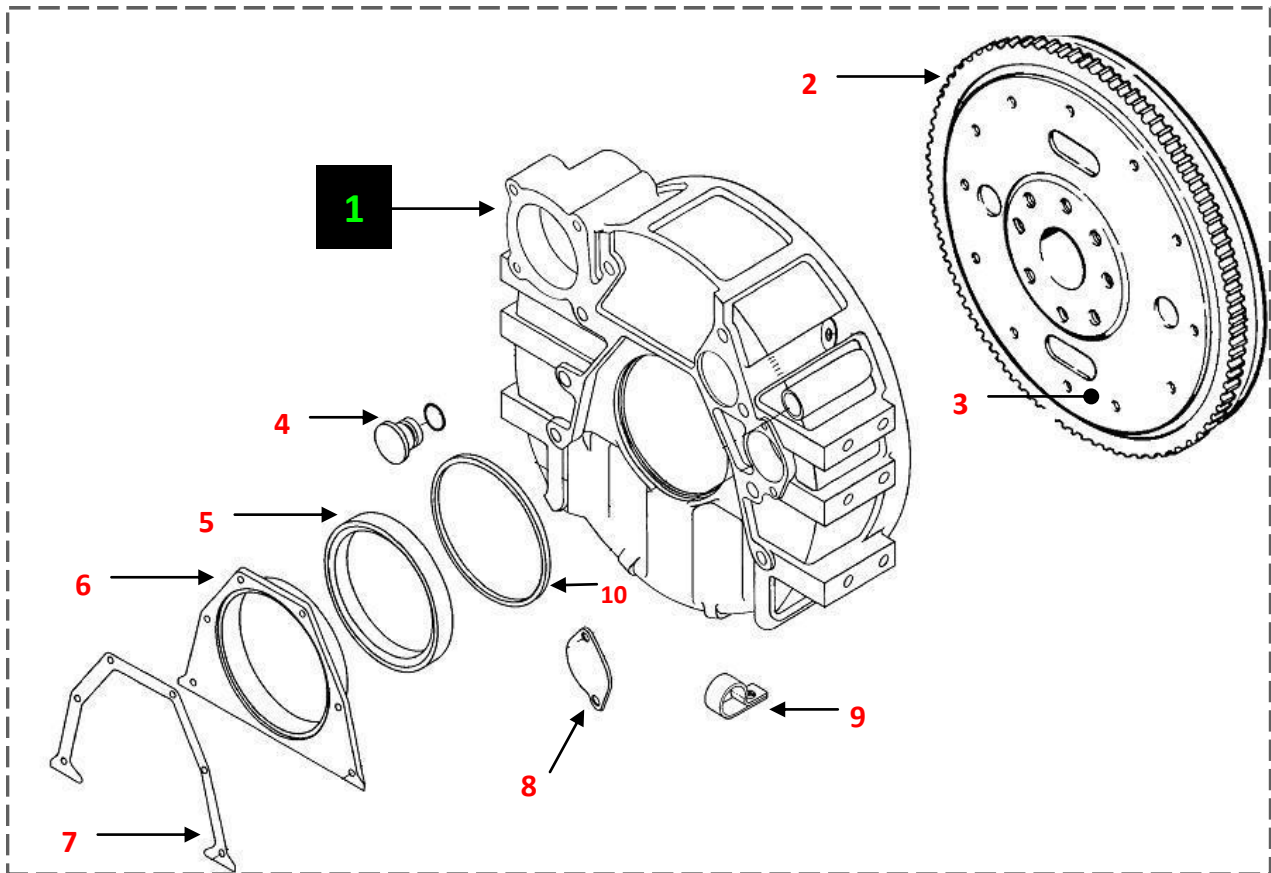

CENMAK REF	CUMMINS REF	DESCRIPTION	PART NO	 6 CT
CCM40749	3930903	Cover Valve	1	
CCM40562	3905449	Cover Valve Gasket	2	
CCM40755	3902468-3902461	Cap oil filler	3	
CCM40758	3902466	Seal	4	
CCM40759	3901838	Bolt	5	
		M8 x 1.25 x 56		

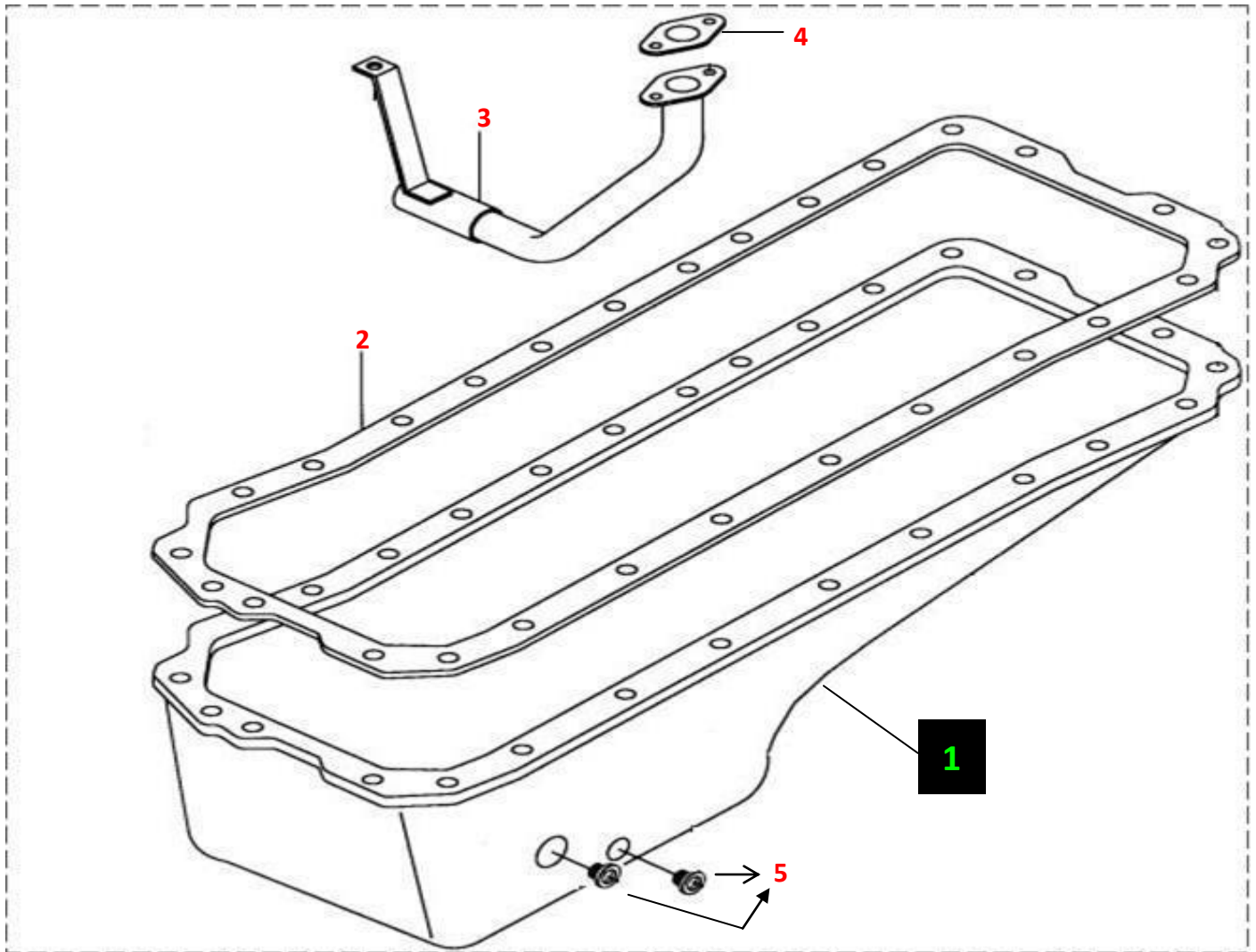

CENMAK REF	DESCRIPTION		CUMMINS REF	PART NO
CCM40760	Housing, Flywheel	4BT 3.9	3904717-3917318	1
CCM40761	Gear, Flywheel Ring		3901774	2
CCM40762	Flywheel		3905882	3
CCM40783	Plug		3910248	4
CCM40764	Seal, Oil		3904089	5
CCM40765	Cover, Rear		3906526	6
CCM40766	Gasket, Rear Cover		3914386	7
CCM40767	Plate, Cover		3908095	8
CCM40768	Clip		3909670	9
CCM40789	Seal, Rectangular Ring		3912473	10
CENMAK REF	DESCRIPTION		CUMMINS REF	PART NO
CCM40760	Housing, Flywheel	6BT 5.9	3913582-3914004	1
CCM40761	Gear, Flywheel Ring		3901774	2
CCM40762	Flywheel		3914431-32	3
CCM40783	Plug		3910248	4
CCM40764	Seal, Oil		3904087-3933262	5
CCM40765	Cover, Rear		3921043	6
CCM40766	Gasket, Rear Cover		3928493-3914386	7
CCM40767	Plate, Cover		3908095- 3925234	8
CCM40768	Clip		3909670- 3928989	9
CCM40789	Seal, Rectangular Ring		3912473	10
CENMAK REF	DESCRIPTION		CUMMINS REF	PART NO
CCM40760	Housing, Flywheel	6CT 8.3	3906690	1
CCM40761	Gear, Flywheel Ring		3907308-3908546	2
CCM40762	Flywheel		3909908-3276905	3
CCM40783	Plug		3910248	4
CCM40764	Seal, Oil		3904087-3925529	5
CCM40765	Cover, Rear		3921042-3907535	6
CCM40766	Gasket, Rear Cover		3914301	7
CCM40767	Plate, Cover		3908095- 3925234	8
CCM40768	Clip		3928989	9
CCM40789	Seal, Rectangular Ring		3912473	10



OIL PAN 4-6 BT / 6 CT

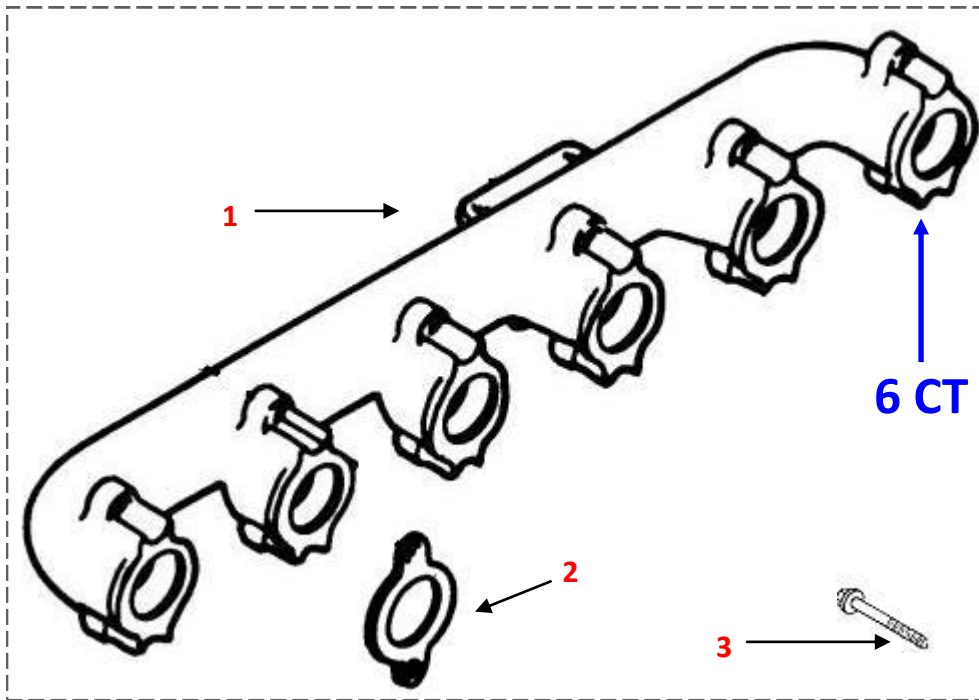
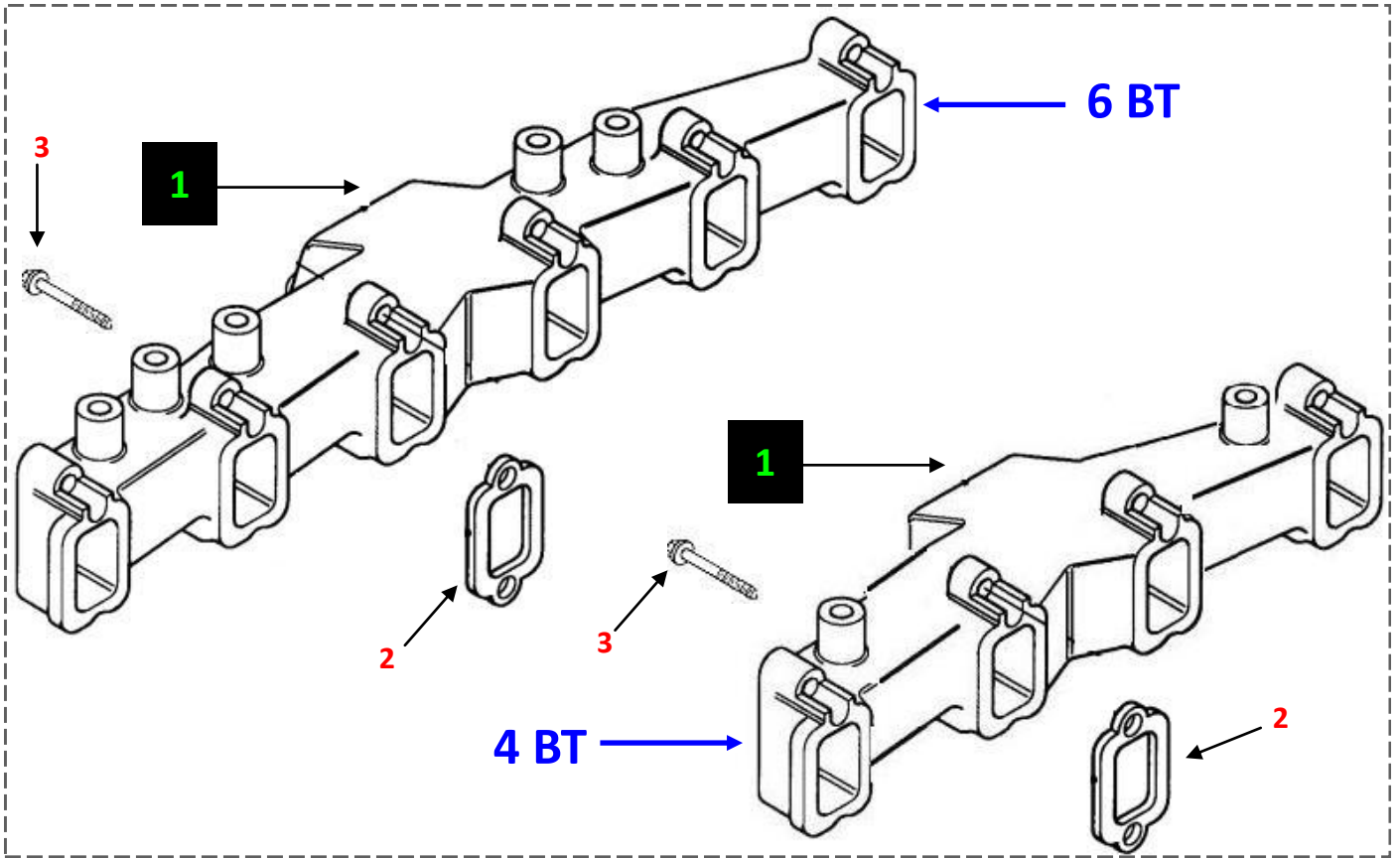

CENMAK REF	DESCRIPTION		CUMMINS REF	PART NO
CCM40887	Oil Pan	4BT 3.9	3901049	1
CCM40587	Gasket, Oil Pan		3911535	2
CCM40888	Connection, Oil Suction		3904474	3
CCM40889	Gasket, Flange		3914383	4
CCM40666	Plug, Threaded		3904386	5
CENMAK REF	DESCRIPTION		CUMMINS REF	PART NO
CCM40890	Oil Pan	6BT 5.9	3901288-3915703	1
CCM40891	Gasket, Oil Pan		3911536-3931346	2
CCM40892	Connection, Oil Suction		3909373-3934942	3
CCM40893	Gasket, Flange		3931349-3914383	4
CCM40894	Plug, Threaded		3924147-3904386	5
CENMAK REF	DESCRIPTION		CUMMINS REF	PART NO
CCM40895	Oil Pan	6CT 8.3	3352546-3914015	1
CCM40896	Gasket, Oil Pan		3934044-3914017	2
CCM40897	Connection, Oil Suction		3912228-3910787	3
CCM40573	Gasket, Flange		3914302	4
CCM40898	Plug, Threaded		3924147-3911638	5

EXHAUST MANIFOLD



CENMAK REF	DESCRIPTION		CUMMINS REF	PART NO
CCM40790	Exhaust Manifold	4BT 3.9	3912600	1
CCM40577	Gasket Exhaust Manifold		3905443	2
CENMAK REF	DESCRIPTION		CUMMINS REF	PART NO
CCM40792	Exhaust Manifold	6BT 5.9	3901961	1
CCM40577	Gasket Exhaust Manifold		3905443	2
CENMAK REF	DESCRIPTION		CUMMINS REF	PART NO
CCM40794	Exhaust Manifold	6CT 8.3	3907451	1
CCM40795	Gasket Exhaust Manifold		3911942-3929012	2
CCM40899	Bolt	4BT-6BT-6CT	3904446	3

THERMOSTAT HOUSING

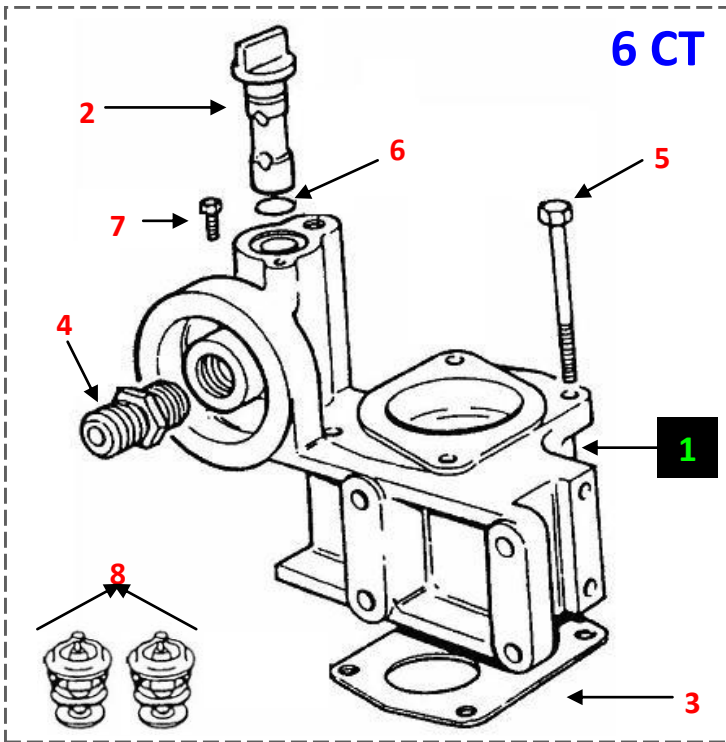

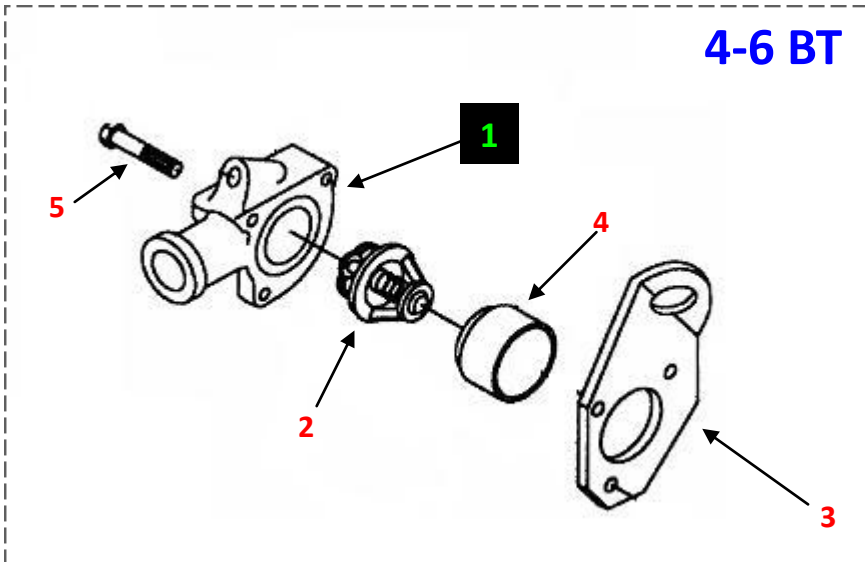

CENMAK REF	DESCRIPTION	CUMMINS REF	PART NO
CCM40801	Thermostat housing	3913708-3928639	1
CCM40802	Shut-off vale	3912837	2
CCM40803	Gasket Thermostat housing	3914310	3
CCM40804	Adapter	C206963	4
CCM40805	Bolt	3902112	5
CCM40806	O-Ring	3818885	6
CCM40807	Bolt	3900625	7
CCM40808	Thermostat (2Pcs)	3907242	8

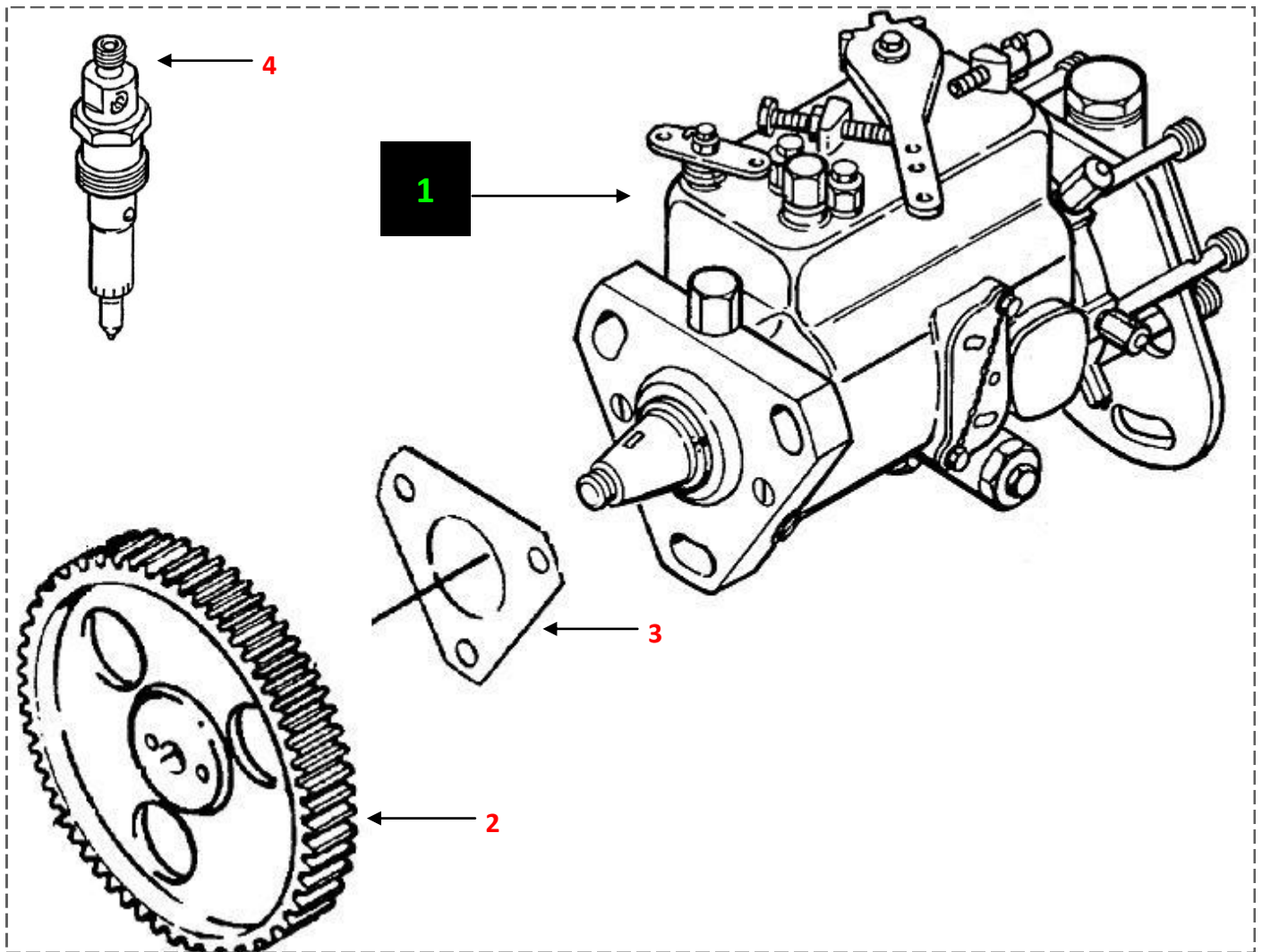

CENMAK REF	DESCRIPTION	CUMMINS REF	PART NO
CCM40796	Thermostat housing	3910627-3802273 3914410	1
CCM40797	Thermostat	3910706-3917324	2
CCM40798	Lifting bracket, front	3903757	3
CCM40799	Gasket	3903301	4
CCM40800	Bolt	3903096	5

FUEL INJECTION / 4 BT



CENMAK REF	DESCRIPTION	 4 BT 3.9	CUMMINS REF	PART NO
CCM40809	Pump, Fuel Injection		3919332-3279516-3900037	1
CCM40810	Gear, Fuel Pump		3912885-3931385	2
CCM40811	Gasket, Fuel Pump		3914389-3931607	3
CCM40812	Injection	3920077	4	

FUEL INJECTION / 6 BT

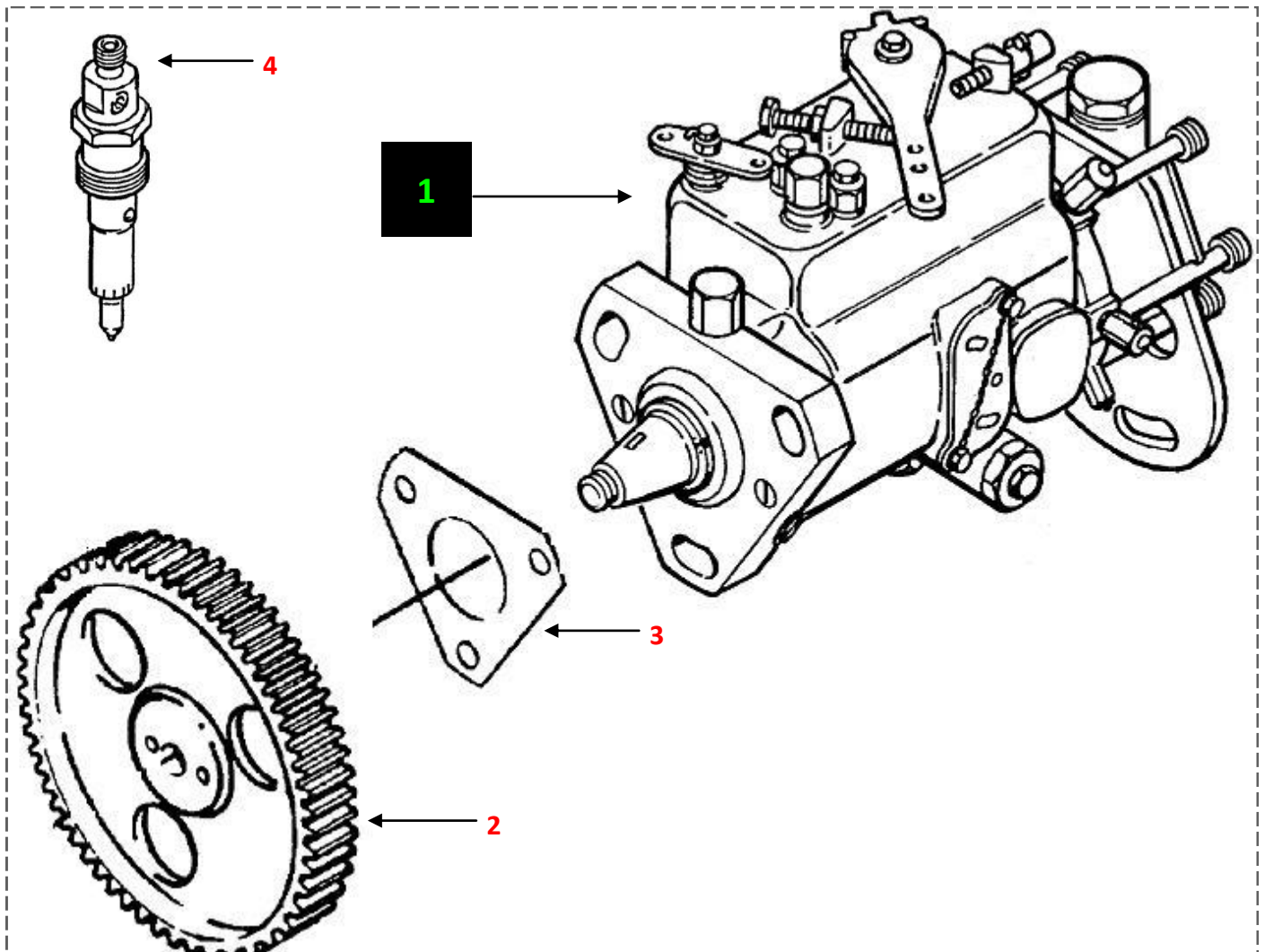

CENMAK REF	DESCRIPTION	 6 BT 5.9	CUMMINS REF	PART NO
CCM40813	Pump, Fuel Injection		3914623-3279279	1
CCM40814	Gear, Fuel Pump		3912885- 3936021	2
CCM40815	Gasket, Fuel Pump		3931607-3914389-3931385	3
CCM40816	Injection	3279343-3280567	4	

FUEL INJECTION / 6 CT

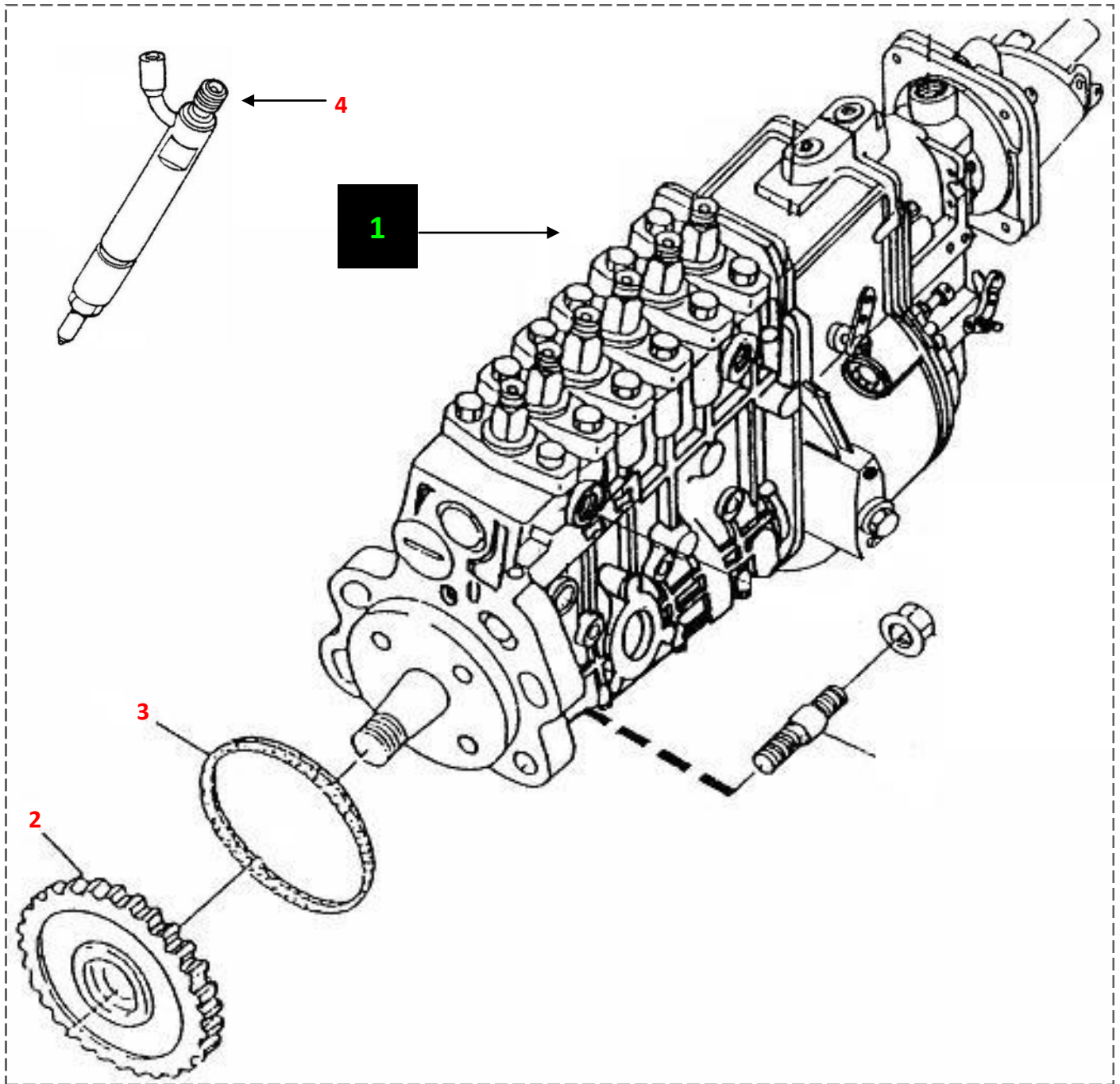

CENMAK REF	DESCRIPTION	 6 CT 8.3	CUMMINS REF	PART NO
CCM40817	Pump, Fuel Injection		3921169-3912643	1
CCM40818	Gear, Fuel Pump		3931384-3931379-3912614	2
CCM40819	O Ring		3910503-3910501	3
CCM40820	Injection		3908507-3913735	4

FUEL PLUMBING

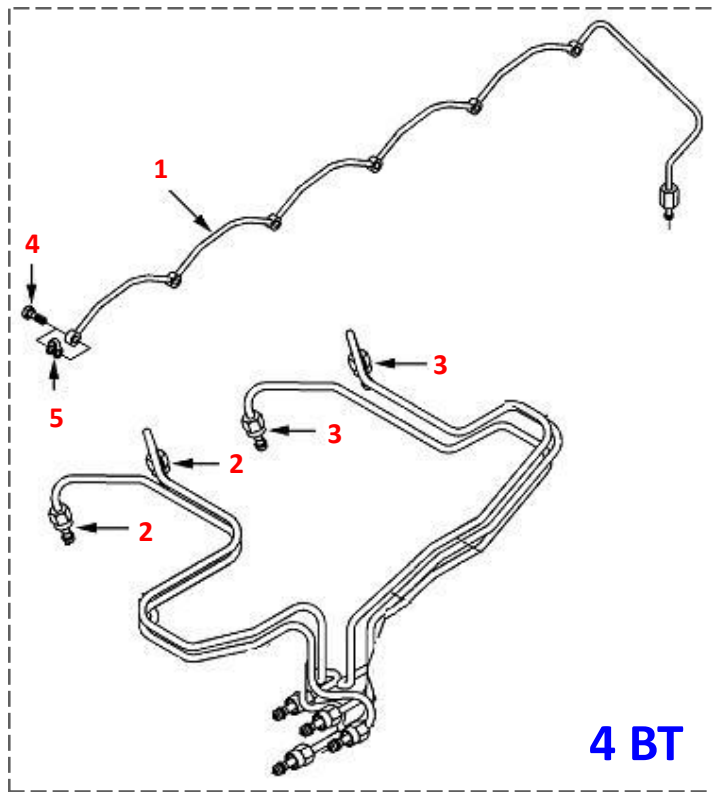

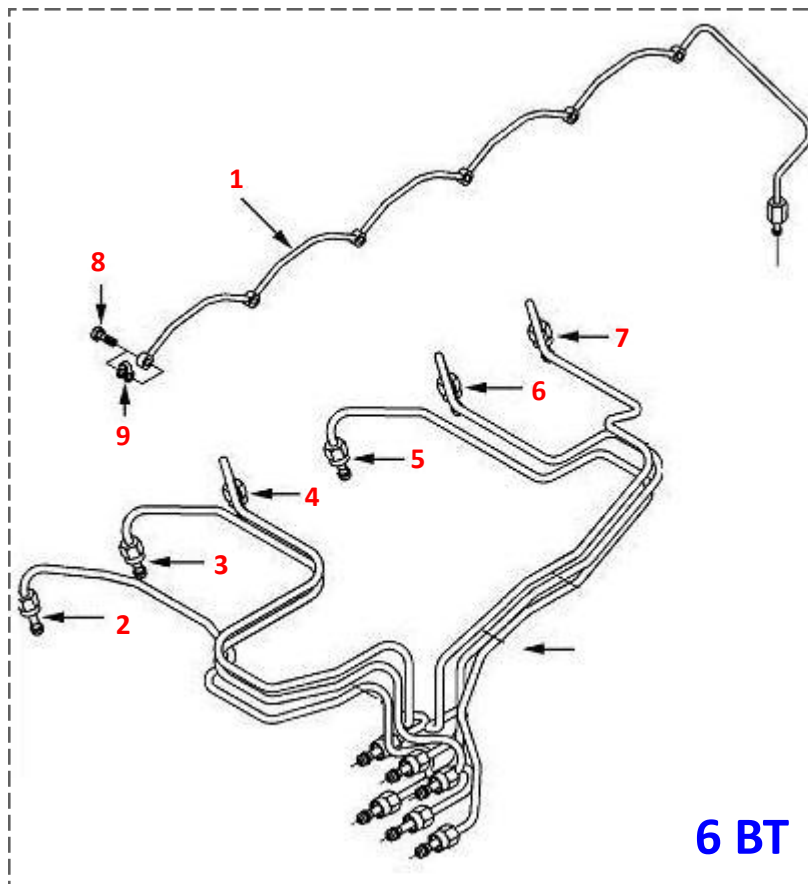

CENMAK REF	DESCRIPTION	4 BT 3.9	CUMMINS REF	PART NO
CCM40821	Injector pipes		3910436	1
CCM40822	Injector pipes		3280511-12	2-3
CCM40823	Bolt		3905307	4
CCM40824	Seal, Banjo Connector		3903380	5

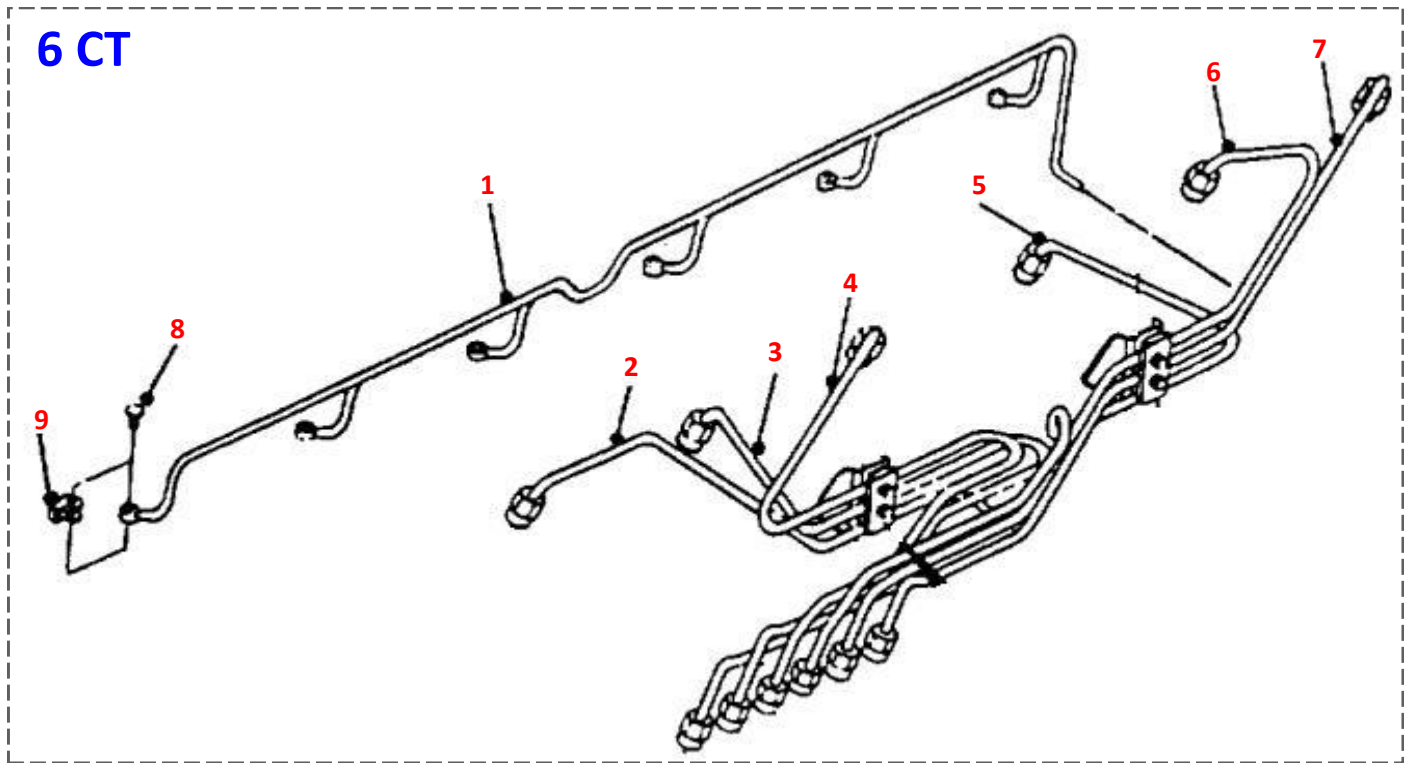

CENMAK REF	DESCRIPTION	6 BT 5.9	CUMMINS REF	PART NO
CCM40825	Injector pipes		3909696	1
CCM40826	Tube, Injector Fuel Supply		3911373-74-75	2-3-4
CCM40827	Tube, Injector Fuel Supply		3911376-77-78	5-6-7
CCM40823	Bolt		3905307	8
CCM40824	Seal, Banjo Connector		3903380	9

FUEL PLUMBING



CENMAK REF	DESCRIPTION	 6 CT 8.3	CUMMINS REF	PART NO
CCM40830	Tube, Injector Fuel Supply		3915903	1
CCM40831	Tube, Injector Fuel Supply		3906783-84-85	2-3-4
CCM40832	Tube, Injector Fuel Supply		3910521-3906787-88	5-6-7
CCM40823	Bolt		3905307	8
CCM40824	Seal, Banjo Connector		3903380	9

ROCKER LEVER MECHANISM

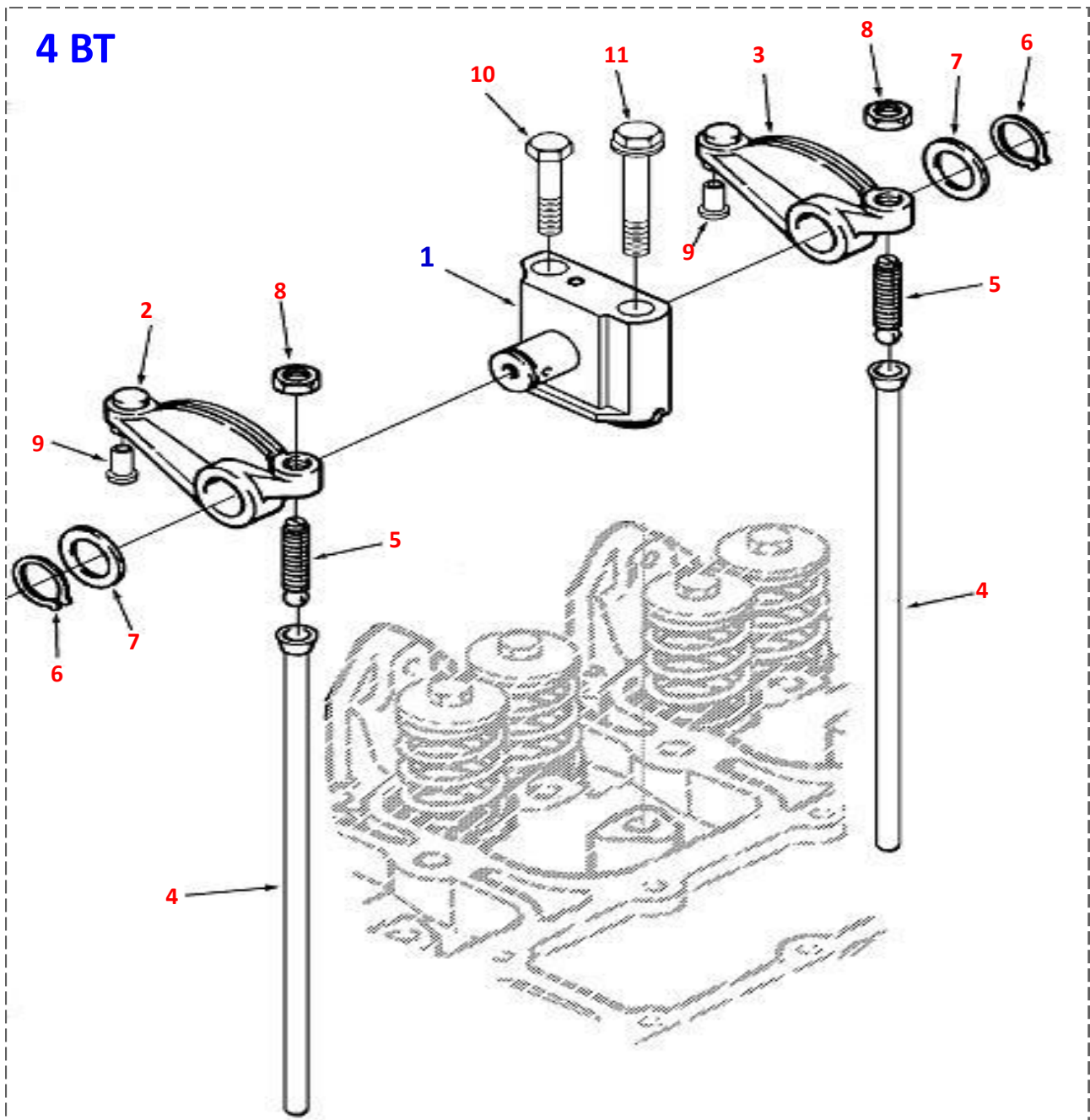

CENMAK REF	DESCRIPTION	CUMMINS REF	PART NO
CCM40835	Rocker Levers	3910815	1
CCM40847	Lever, Rocker	3910811	2
CCM40837	Lever, Rocker	3910810	3
CCM40838	Rod, Push	3904679	4
CCM40839	Screw, Rkr Lever Adjusting	3900706	5
CCM40840	Ring, Retaining	3900242	6
CCM40841	Washer, Plain	3900245	7
CCM40842	Nut, Heavy Hexagon	CS-276	8
CCM40843	Pad,wear	3912881	9
CCM40844	Screw, Hexagon Head Cap	3901221	10
CCM40845	Screw, Hexagon Head Cap	3903940	11

4 BT 3.9

ROCKER LEVER MECHANISM

6 BT

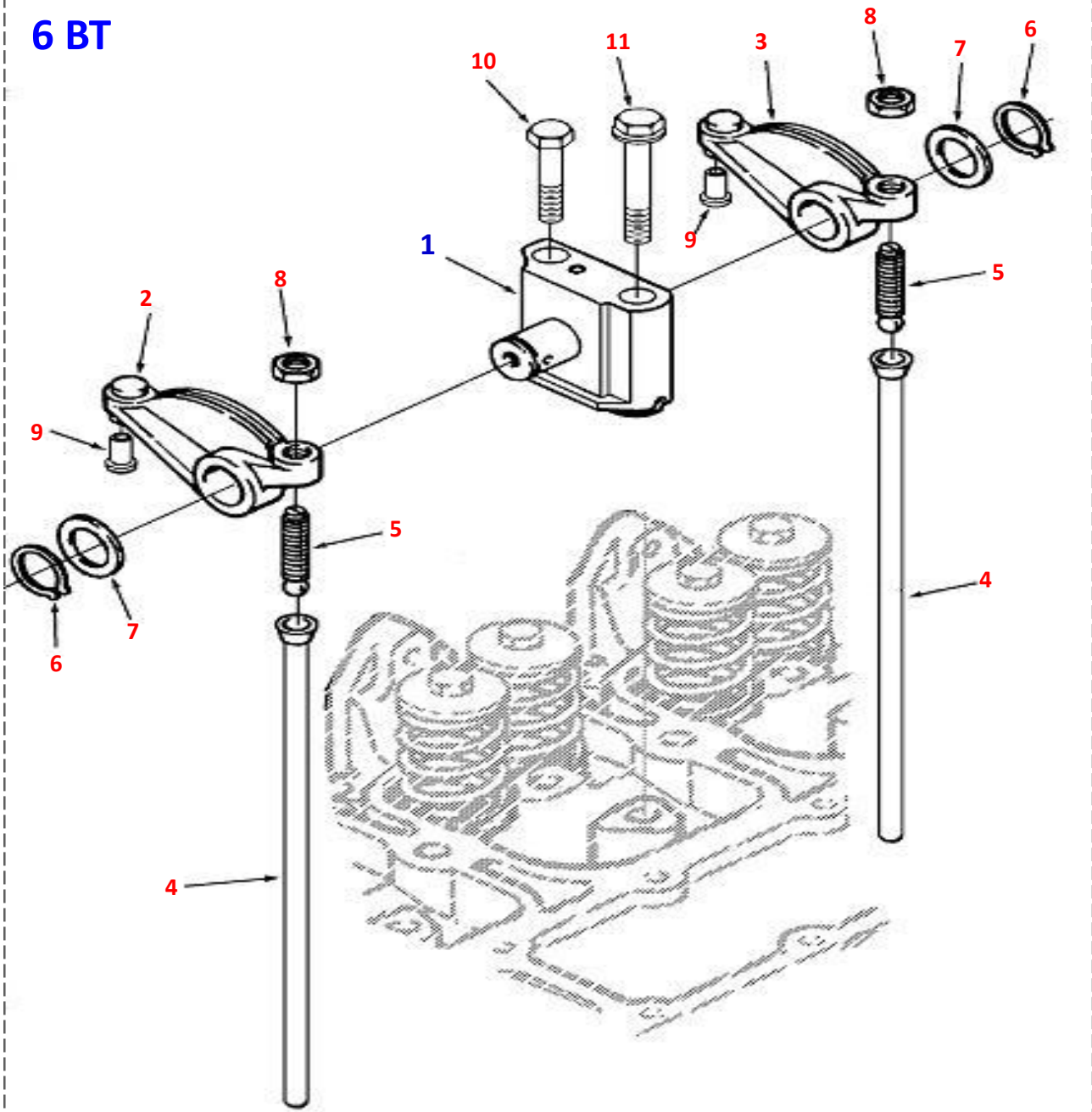

CENMAK REF	DESCRIPTION	CUMMINS REF	PART NO
CCM40846	Rocker Levers	3910816	1
CCM40847	Lever, Rocker	3910811	2
CCM40837	Lever, Rocker	3910810	3
CCM40838	Rod, Push	3904679	4
CCM40839	Screw, Rkr Lever Adjusting	3900706	5
CCM40840	Ring, Retaining	3900242	6
CCM40841	Washer, Plain	3900245	7
CCM40842	Nut, Heavy Hexagon	CS-276	8
CCM40843	Pad,wear	3912881	9
CCM40844	Screw, Hexagon Head Cap	3901221	10
CCM40845	Screw, Hexagon Head Cap	3903940	11

6 BT 5.9

ROCKER LEVER MECHANISM

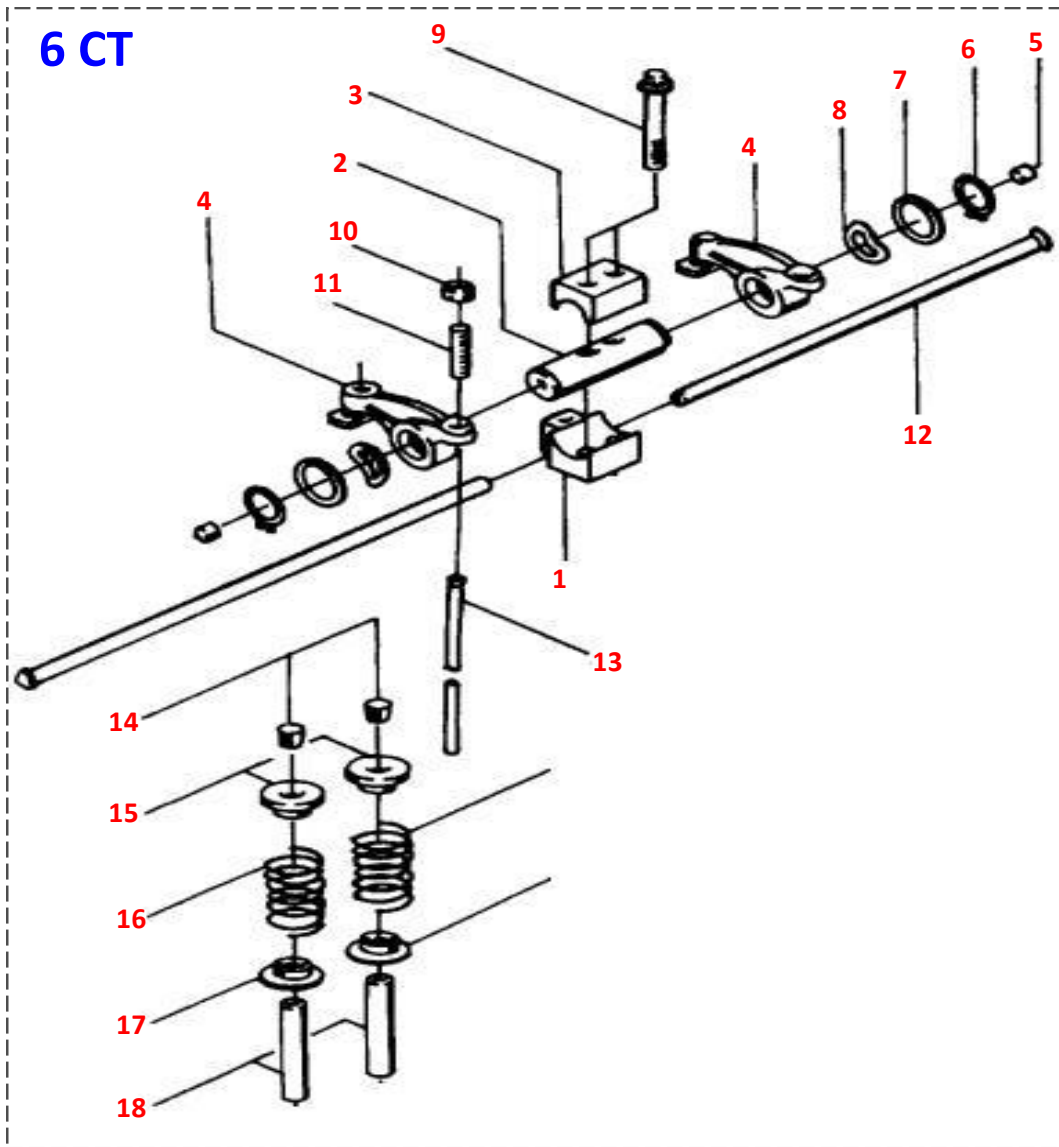

CENMAK REF	DESCRIPTION	CUMMINS REF	PART NO
CCM40857	Rocker Levers	3905870	1
CCM40858	Shaft, Rocker Lever	3919435-3906249	2
CCM40859	Clamp, Retaining	3901693	3
CCM40860	Lever, Rocker	3901717	4
CCM40861	Plug, Expansion	3907555	5
CCM40862	Ring, Retaining	3901764	6
CCM40863	Washer, Plain	3907206	7
CCM40864	Washer, Spring	3906100	8
CCM40865	Screw, Twelve Point Cap	3901617	9
CCM40866	Nut, Heavy Hexagon	3927692	10
CCM40839	Screw, Rkr Lever Adjusting	3900706	11
CCM40868	Oil pipe	3919677-3910911	12
CCM40869	Rod, Push	3905194	13
CCM40870	Collet valve	3901177	14
CCM40871	Retainer valve, spring-Top	3912976	15
CCM40872	Spring valve intake	3908055	16
CCM40873	Guide valve spring Bottom	3901178	17
CCM40534	Guide valve spring	3901187	18

ENGINE FILTERS

CENMAK REF	CUMMINS REF	DESCRIPTION	ENGINE	FLEETGUARD REF
CCM40908	FF5074	Fuel, Spin-On	6BT-6BTA	FF5074
CCM40909	3931065-3931063-3903640-3890707	Fuel, Spin-On	4BT-6BT-6BTA	FF5052
CCM40910	3935274-3930942-3925274-3903410-3890706	Fuel/Water Sep Spin-On	4BT-6BT-6BTA-6CT-6CTA	FS1280
CCM40911	3932218-3932217-3914395-3908615-3903264-3890708	Lube, Full-Flow Spin-On	6BT-6BTA	LF3349
CCM40912	3903224	Lube, Full-Flow Spin-On	4BT-4BTA	LF3345
CCM40913	3315789-3315116-3314581	Water, Spin-On 4 <i>Unit</i>	6CT-6CTA-NTA855-NH220	WF2071
CCM40914	3316053	Water, Spin-On 12 <i>Unit</i>	N14-NH220-NT855C10	WF2074
CCM40915	3318853-3825970	Lube, Spin-On	6CT-6CTA-N-NT-NTA855-NTC SERIES	LF3000
CCM40916	3014654-3310442-3313281	Lube, Full-Flow Spin-On	6CT-6CTA-6CTAA	LF734
CCM40917	3401544	Lube, Spin-On	6CT-6CTA-6CTAA-M11-N14-NT855	LF9009
CCM40918	3937743-3937695-3937211-3937146-3937145	Lube, Full-Flow Spin-On	6BT-6BTA	LF3959
CCM40919	3101869	Lube, Spin-On	M11	LF9001
CCM40920	LF16015-4897898	Lube, Spin-On	6BT-6BTA	LF16015
CCM40921	3959612	Fuel	M11/ 350 HP EURO2	FF5488
CCM40922	3329289-3161407-3889716	Fuel/Water Sep Spin-On	M11-NT855	FS1000
CCM40923	4894548-4897833	Fuel	6BT-6BTA	FF5485
CCM40924	3800394	Fuel/Water Sep Spin-On	6BT-6BTA	FS1022
CCM40925	3406889	Fuel/Water Sep Spin-On	N14	FS1003
CCM40926	AR13242-3827107-3305371-299084-4058965	Water, Spin-On 23 <i>Unit</i>	N14-NTA855-NTC	WF2076
CCM40927	---	Fuel, Spin-On	6BT-6CT	FF5167
CCM40928	3903640-3931065	Fuel, User Friendly Version		FF42000

